

Universal Motor - UK Series

Voltage : 100 - 240V AC (50/60Hz)
 Rated Speed : 12,000 - 18,000rpm
 Rated Output Power: 150 - 450W
 Insulation Class : A, B, F, H
 Motor Diameter : Ø82mm[3.23inch]
 Typical Application : Grass Trimmer, Juice Extractor, Water Pump, Food Processor, Meat Grinder, Drink Mixer, Stand Mixer, Blender

Performance Curve

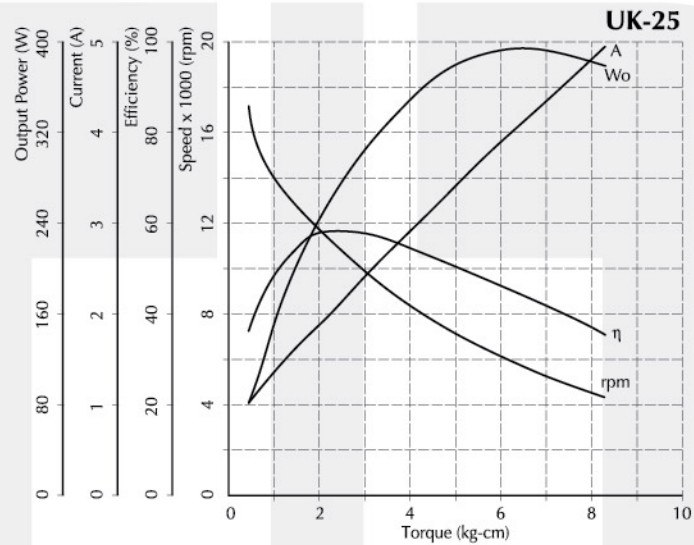

Dimension (mm[inch])

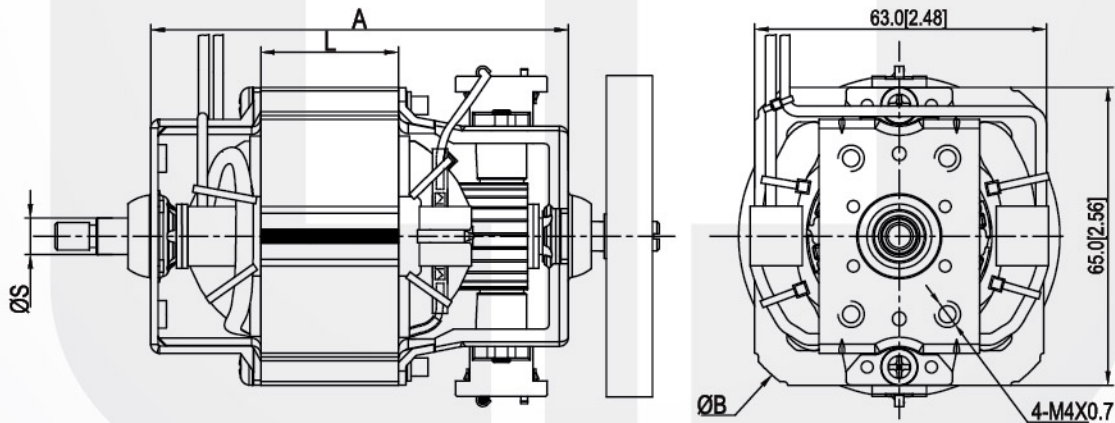

Performance (testing under room temperature)

Model	Dim A mm[inch]	Dim B mm[inch]	Dim L mm[inch]	Dim S mm[inch]	Rated Torque (kg-cm)[lb-in]	Rated Output Power (W)
UK-15	76.0 [2.99]	82.0 [3.23]	15.0 [0.59]	6.35 - 8.0 [0.25 - 0.31]	0.1 - 2.0 [0.09 - 1.73]	110 - 220
UK-20	81.0 [3.19]	82.0 [3.23]	20.0 [0.79]	6.35 - 8.0 [0.25 - 0.31]	1.0 - 3.0 [0.87 - 2.60]	165 - 275
UK-25	86.0 [3.39]	82.0 [3.23]	25.0 [0.98]	6.35 - 8.0 [0.25 - 0.31]	1.5 - 3.5 [1.30 - 3.04]	220 - 330
UK-30	91.0 [3.58]	82.0 [3.23]	30.0 [1.18]	6.35 - 8.0 [0.25 - 0.31]	2.0 - 5.0 [1.73 - 4.34]	275 - 470
UK-35	96.0 [3.78]	82.0 [3.23]	35.0 [1.38]	6.35 - 8.0 [0.25 - 0.31]	2.0 - 6.0 [1.73 - 5.20]	350 - 550
UK-40	101.0 [3.98]	82.0 [3.23]	40.0 [1.57]	6.35 - 8.0 [0.25 - 0.31]	3.0 - 6.0 [2.60 - 5.20]	440 - 650

The information above is for reference only, detailed specification is subject to final confirmation

Email: sales@cclmotors.com Website: <http://www.cclmotors.com>
 4/F, No. 6, On Lok Mun Street, On Lok Tsuen, Fanling, N.T., Hong Kong.

Tel: (852) 3125 0000 Fax: (852) 3125 0125