

Transaxle - GT48D-15 Series

Voltage : 24 - 48V DC
 Rated Speed : 163 - 220rpm
 Rated Output Power: 800 - 1,500W
 Gear Ratio : 15.3 : 1, 20.9 : 1
 Rated Torque : 312.9-542.2kg-cm[271.58-470.61lb-in]
 Loading Capability : 2,259.6kg-cm[1,961.24lb-in]
 Motor Diameter : Ø122.9mm[4.84inch]
 Typical Application : Electric Scooter, Golf Cart, Extra Heavy Duty Scooter

Performance Curve

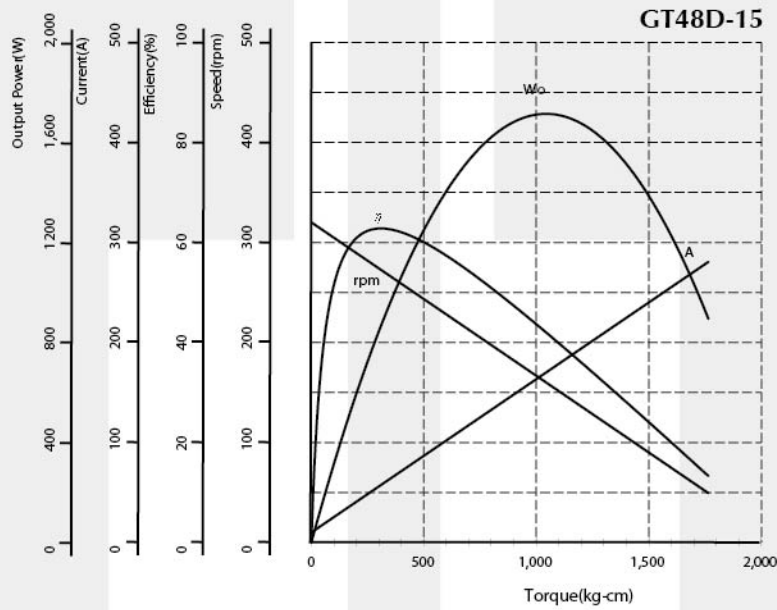

Dimension (mm[inch])

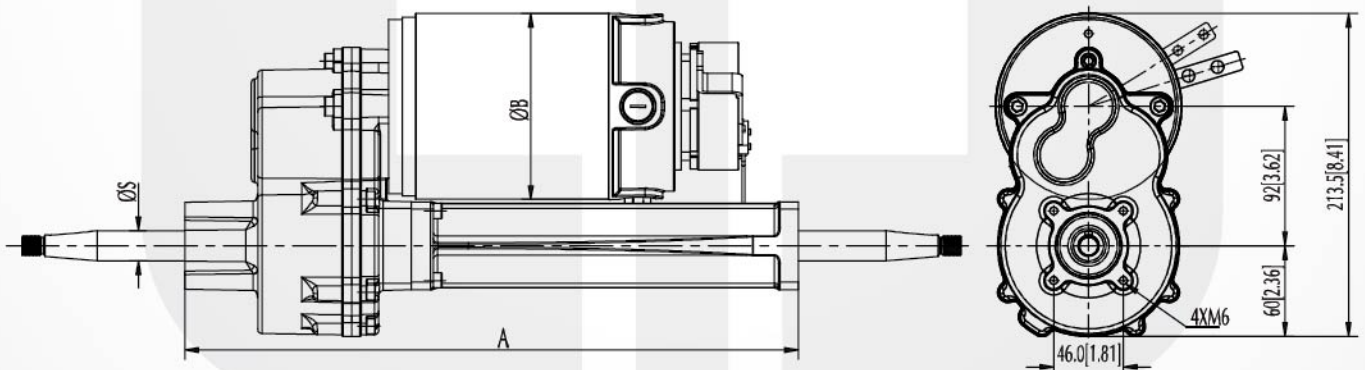

Performance (testing under room temperature)

Model	Dim A mm[inch]	Dim B mm[inch]	Dim S mm[inch]	Gear Ratio	Rated Voltage (V DC)	No Load		At Maximum Efficiency				Max Power		
						Speed (rpm)	Current (A)	Torque (kg-cm[lb-in])	Speed (rpm)	Current (A)	Output (W)	Effic'y (%)	Torque (kg-cm[lb-in])	Current (A)
GT48D-15-01	405[15.94]	122.9[4.84]	25[0.98]	20.9:1	24	220	9.5	542.2[470.61]	194	65	1,078	69	2,259.6[1,961.24]	241
GT48D-15-02	405[15.94]	122.9[4.84]	25[0.98]	15.3:1	24	320	10	312.9[271.58]	272	58	874.2	62.8	1,043.2[905.46]	170

The information above is for reference only, detailed specification is subject to final confirmation

Email: sales@cclmotors.com Website: <http://www.cclmotors.com>
 4/F, No. 6, On Lok Mun Street, On Lok Tsuen, Fanling, N.T., Hong Kong.

Tel: (852) 3125 0000 Fax: (852) 3125 0125